



Cable Trays Pvt Ltd

Corporate broucher
of our company & our product details



PRODUCT Broucher

**Perforated Cable Trays is What You Need,
Get the Best from The Best !**

One stop solution for all the products that are used
in cable support management systems.



www.nskscabletrays.com



At NSKS Cable Trays Pvt Ltd, let us take the opportunity to introduce and embark ourselves as one of the prominent cable trays manufacturing companies in the country.

NSKS Cable Trays Pvt Ltd is a well-known and reputed cable tray manufacturer providing superior quality services at competitive prices.

About the Company

The company was established in 2018 with a name - NSK Cable Trays. The company was Initiated as a manufacturing proprietor firm and was performing well in the market. However, the founders had bigger dreams and aimed to expand their business. Hence, in September 2020 the company went on to convert itself to NSKS Cable Trays Pvt Ltd.

The professionals at NSKS Cable Trays have put in many efforts and time in conducting a plethora of research activities. Over the years, these researches have become a base for us to design and develop the huge and diverse product line suits the customers' needs and wants. In our two-year journey, we have always thrived hard to offer the best to our clients.

We believe in hustling each day by providing innovative and the right business solutions throughout. For NSKS Cable Trays, client satisfaction is the utmost priority. You can rely on our quality, and we assure you that we will never disappoint you.

Major ACHIEVEMENTS OF THE COMPANIES



- * Certifications : ISO 90001: 2015
- * Certifications : ISO 14001: 2015
- * Certifications : Import & Export Code (IEC Code)
- * Certifications : MSME Registered
- * Certifications : Labor License

NSKS Cable Trays is one of the only cable tray manufacturing companies which has achieved almost all mandatory quality certificates in two years.



Our USP

The biggest USP of NSKS Cable trays is that, we manufacture our very own Dyes & Tools at our premises and each product is customized as per the needs and wants of the customer.



Our Major Milestone

In the cutting-edge competition industry, NSKS Cable Trays has managed to grow itself immensely, in just 24 months. The company currently has a turnover of about five crores plus, which is a great number to achieve in the initial years.



Past WORKS



Over the years, we have supplied to Major

- MNC Companies & Pharma
- Constructions Companies project



We have successfully supplied at multiple locations such as

Pune, Bombay, Vishakhapatnam, Bangalore, Hyderabad, Warangal, Andhra Pradesh, Orissa, Nagpur, etc.

Total Number of Projects : 100 + IN TWO YEARS

Major PROJECTS

- Tata Steel Special Economic Zone (Orissa)
- GVK (Bangalore)
- IIT (Tirupathi)
- BIOCON (SEZ Ramky Pharma City)
- Sysmbiosis (Nagpur)
- Mahindra Educational Institute
- D.E. Shaw India Pvt Ltd
- GMR Hall (Public Plaza)
- Apple India Pvt Ltd
- Microsoft India (Knowledge City)
- Salesforce India Pvt Ltd
- Flipkart Data Center
- AIIM Hospital (Nagpur)
- My Home Residential Project
- Amazon Center
- GMR Airport Hyderabad





Vision

To continuously provide premium quality products to become the number one player in the cable tray manufacturing industry.



Mission

To constantly grow as a company by manufacturing super quality and customized cable support management products.

Our PRODUCTS

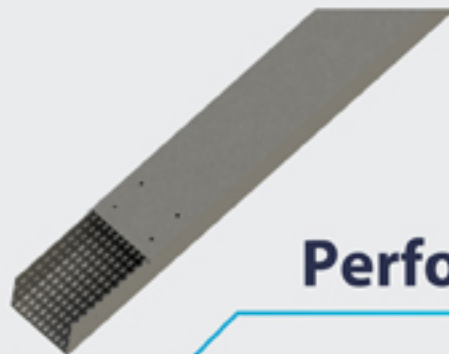
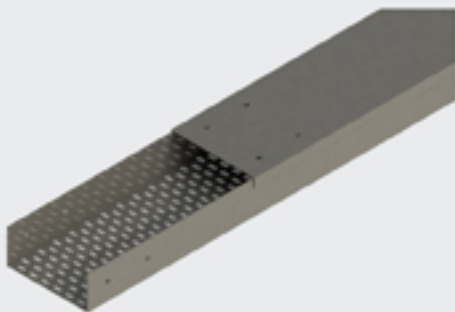

Perforated Cable Tray

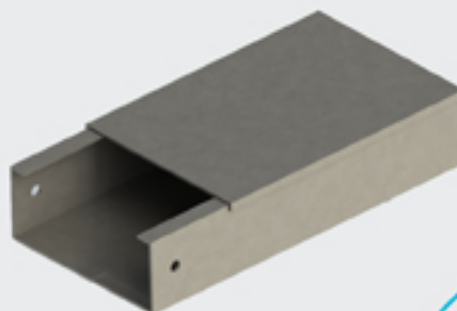
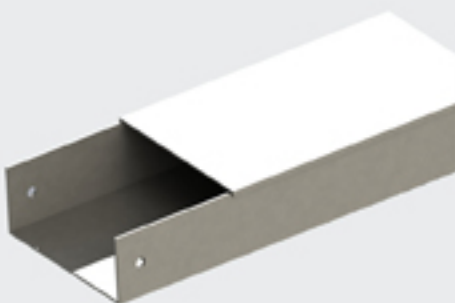

Raceway

Perforated Cable Tray Type Bends

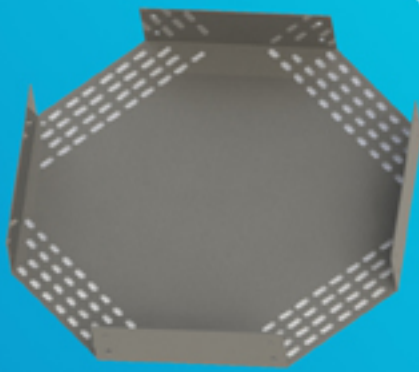

90 Degrees Horizontal Cross Bend

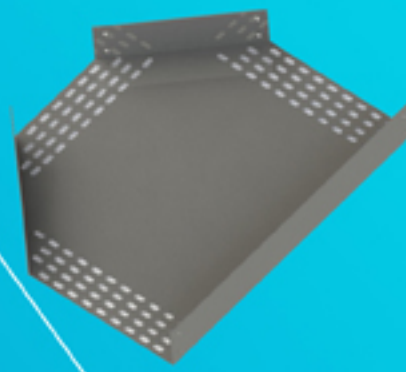

90 Degrees Horizontal Tee Bend

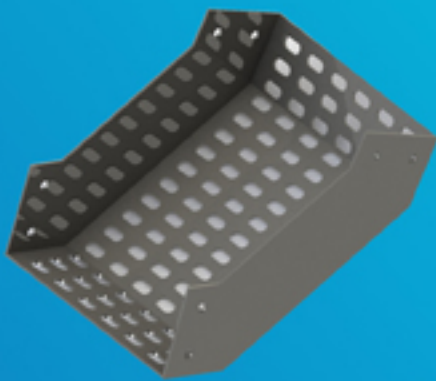

90 Degrees Vertical Inside

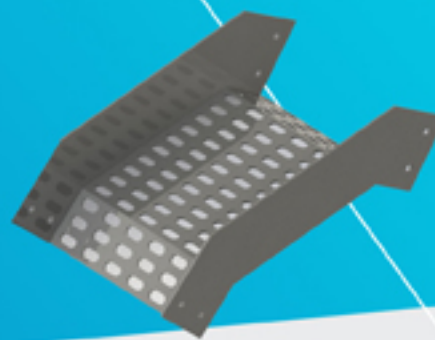

90 Degrees Vertical Outside

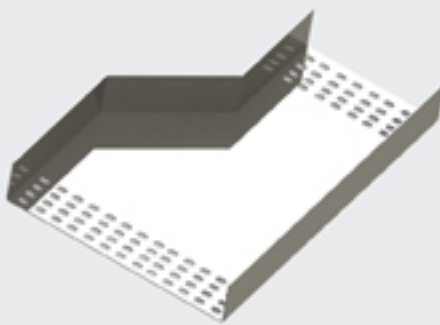

Reducer LH

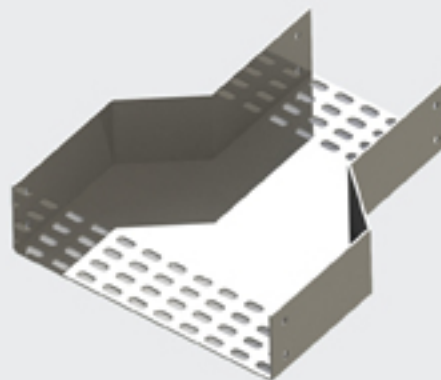

Central Reducer

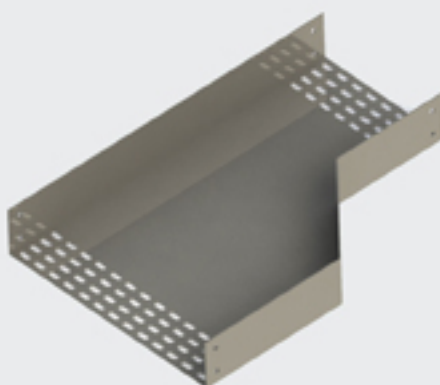

Reducer RH



90 Degrees Horizontal Bend

Ladder Type Bends



90 degrees Vertical Outside



90 degrees Horizontal



90 degrees Horizontal Cross

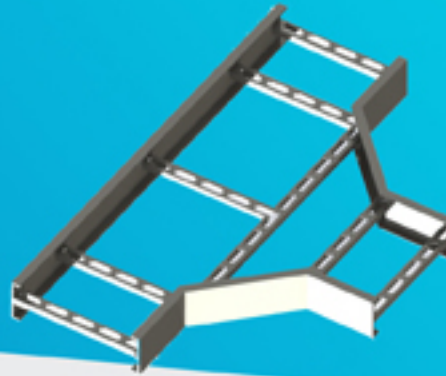

90 degrees horizontal tee



90 degrees vertical Inside



Central Reducer



Reducer RH



Reducer LH

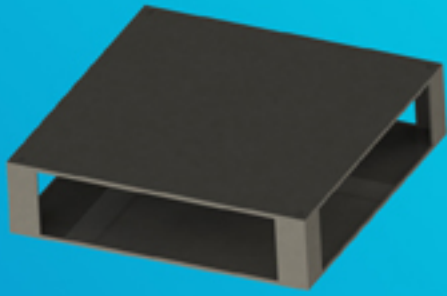

Junction Box



Bolted Ladder Type Tray



Welded Ladder Type Tray

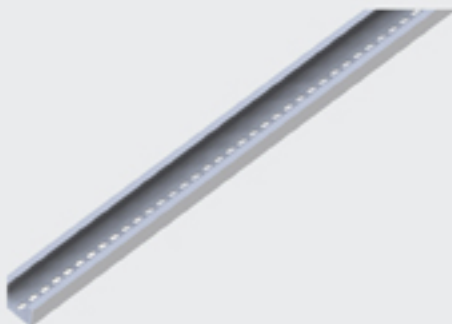

Slotted C Channel



Strut Channel

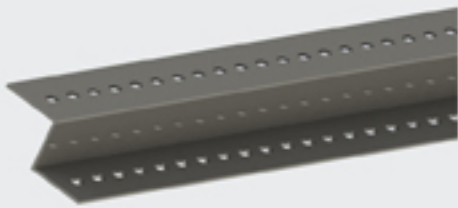

Z section



Bottle Bracket



Cable Binder



Solar Structure

Solar Attach Model

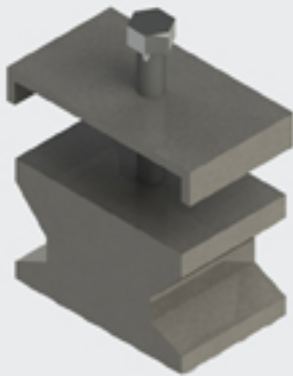

Threaded Rod

www.nskscabletrays.com



Earth Strips



Clamps

Our CORE VALUES

- * Hard-Core Innovation
- * Effective Communication
- * Quality Assurance
- * Timely Delivery
- * Transparency and Loyalty



What are Clients Talk About Us

It is our quality of work which speaks volume for ourselves.

Here is what our clients have been talking about us:



Client Testimonial 1

It was a pleasure getting associated with NSKS Cable Trays, and we were impressed with the kind of quality services provided in a short period.

Client Testimonial 2

The professionals' approach at NSKS Cable Trays, right from the beginning was on point. The communication was also seamless, and we did not face any loophole.

Client Testimonial 3

The best part was that they customized each and every product as per our customization requirements. We just had to tell them our needs, and they left no stone unturned in fulfilling all our needs in the best way possible.

Client Testimonial 4

The Dyes and tools provided by NSKS Cable trays were of excellent quality. They were versatile enough as we could use them at multiple places.



REACH OUT to us right here



Office Location :

Plot No:1, Road No:3, Satellite Industrial State (SIE), Shivalayam Road, Balanagar, Hyderabad- 500037.



Contact Details :

Phone: +91 9515047239, +91 9515077063



Email :

info@nskscabletrays.com, enquiry@nskscabletrays.com

For more news and updates about us, keep following us on

